

Progressive Safety System (BSIS+MOIS)



INTRODUCTION

The Progressive Safe System (PSS) is a collection of safety equipment designed to improve driver and VRU awareness of the dangers around them and physical safety barriers.

To meet this standard, Unique Technology develop a completely solution to solve this issue by using the latest 77Ghz millimetre-wave radar technology to meet the DVS 2024 requirements.

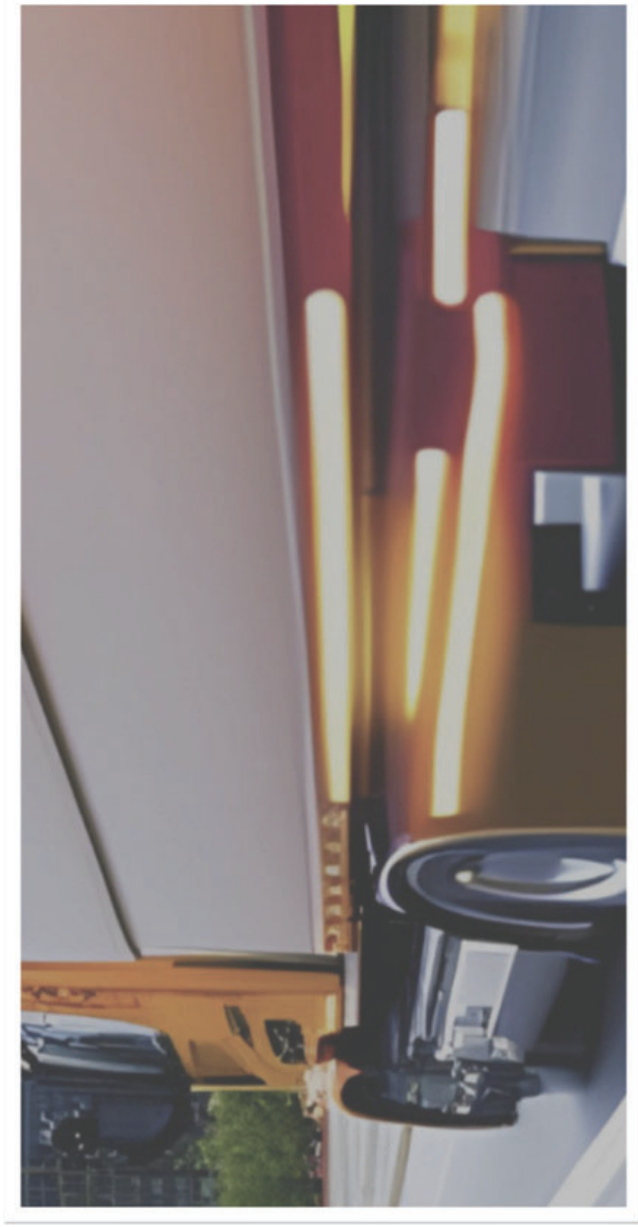

Warning Area



MAIN PARTS

Part Name	Qty
180 MOIS radar	1 pc
BSIS radar	1pc
LED display (with GPS built in)	1 pc
Harness	1 set
Installation kits	1 set

WIRING DIAGRAM

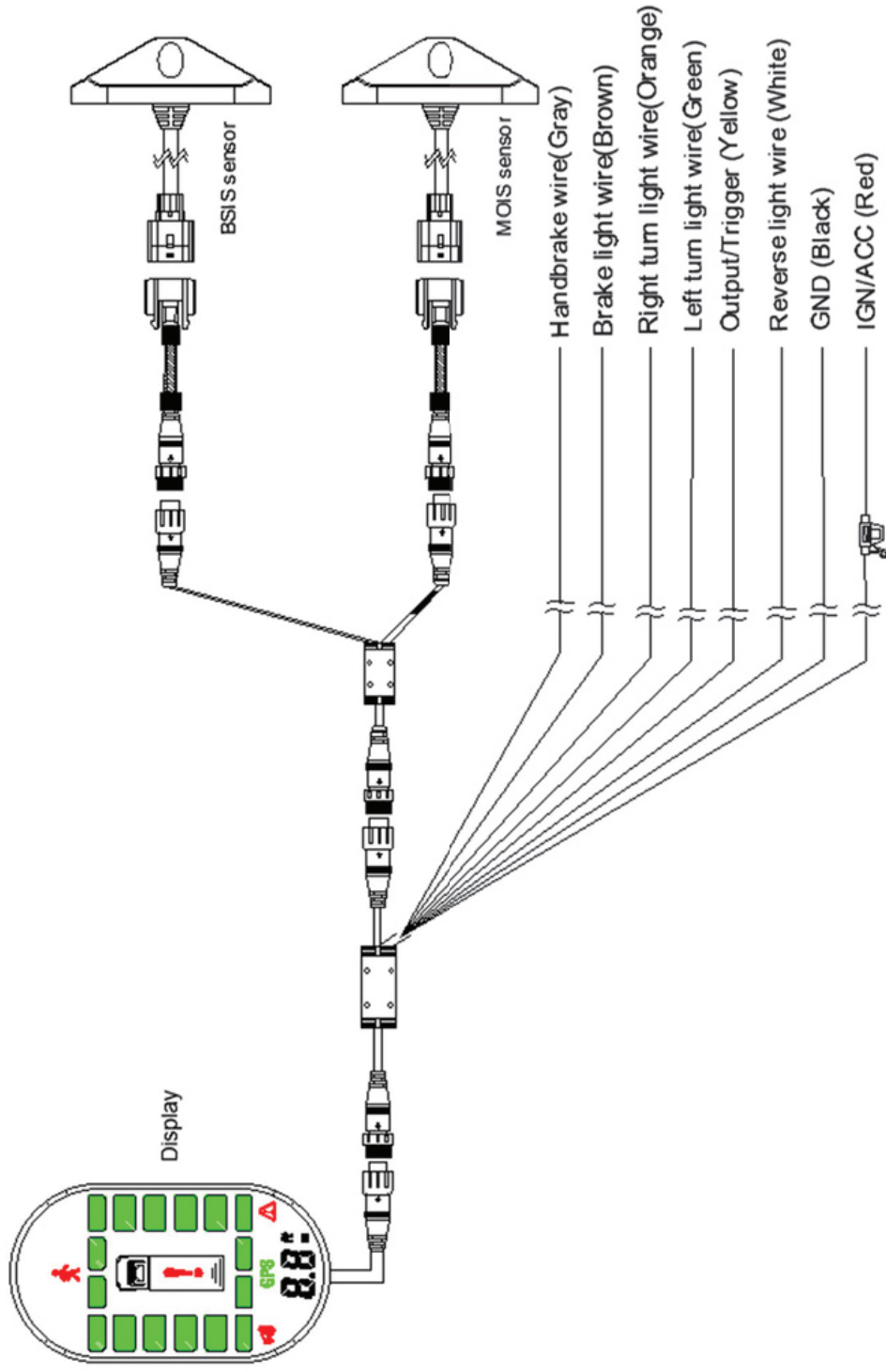

INSTALLATION

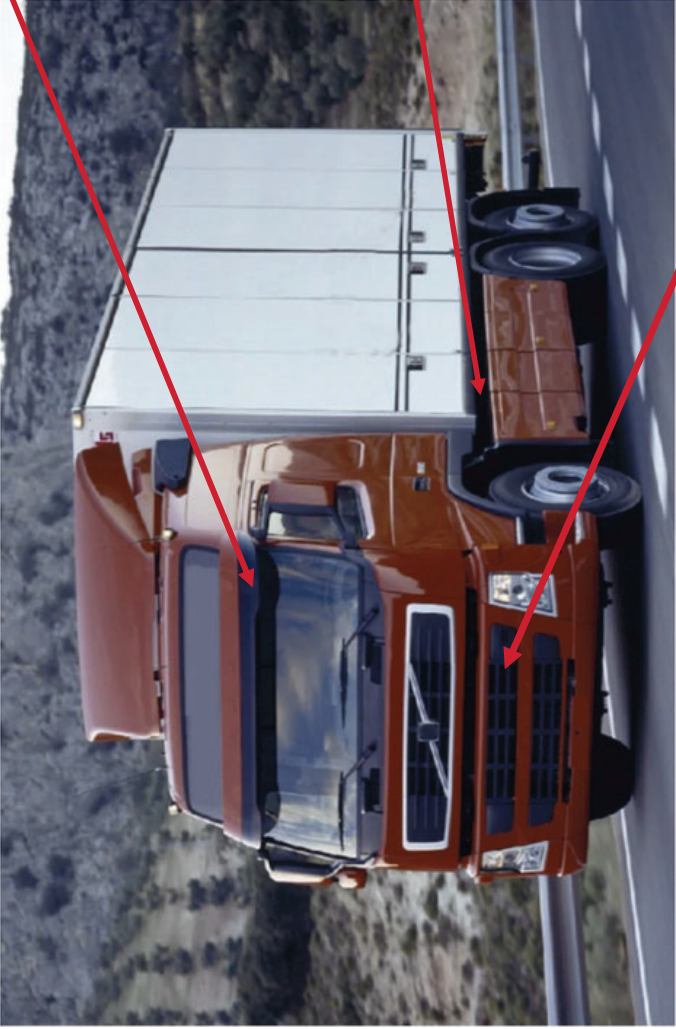

APPEARANCE&SIZE-RADAR

Unit: mm

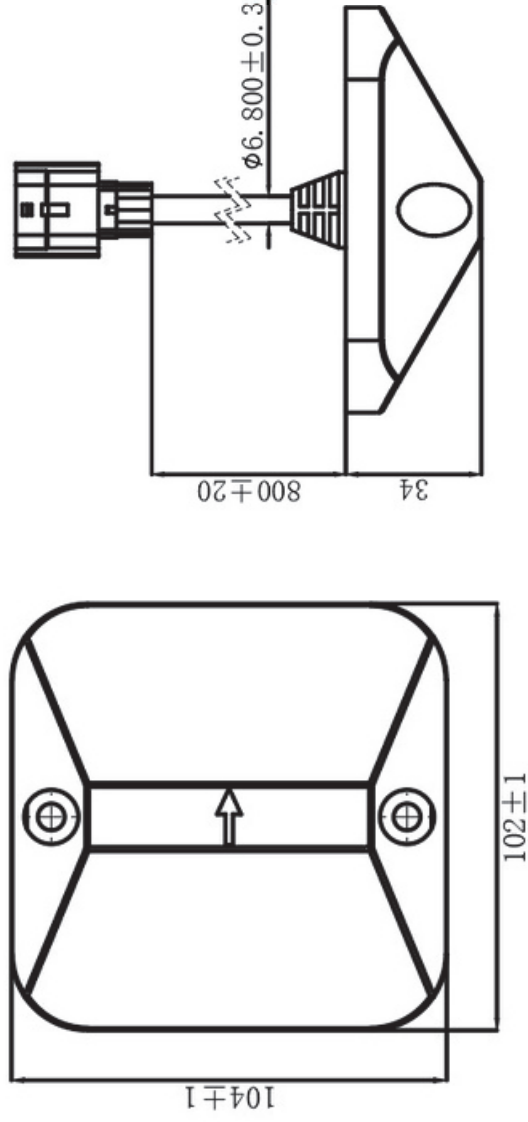

APPEARANCE&SIZE-DISPLAY

Unit: mm

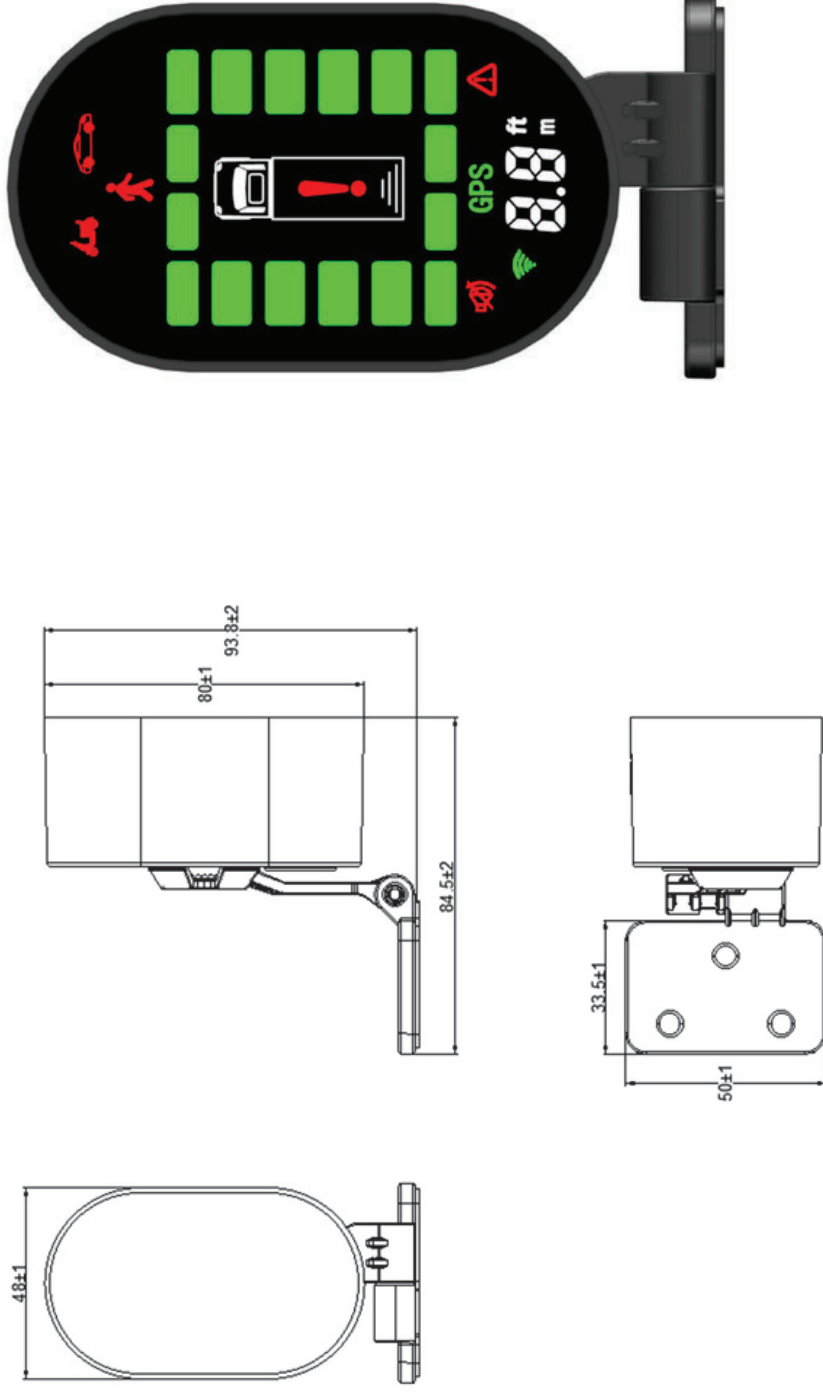

BSIS Radar Specifications

ITEM	Parameter	ITEM	Parameter
Rated working voltage (V)	12V/24V	Horizontal angle (°)	180°
Operating voltage range (V)	9-32V	Vertical angle (°)	30°
Power consumption	< 6W	Angle accuracy (°)	±0.5 @ 40°
Operating temperature range (°)	-40 ~ +85°C	Angular resolution (°)	18
Storage temperature range (°)	-40 ~ +95°C	Speed Range (km/h)	-150 ~ +150
Working frequency (GHz)	76-77	Speed Accuracy (m/s)	0.15
Transmit power (dBm)	12	Detectability (m)	65m
Modulation mode	FMCW	Distance Accuracy (m)	0.13
Antenna form	4TX, 4RX	Distance Resolution (m)	0.19
Traceable target number _{MAX}	31	Waterproof grade	IP6K7

MOIS Radar Specifications

ITEM	Parameter	ITEM	Parameter
Rated working voltage (V)	12V/24V	Horizontal angle (°)	180°
Operating voltage range (V)	9-32V	Vertical angle (°)	30°
Power consumption (°)	< 6W	Angle accuracy (°)	±0.5 @ 40°
Operating temperature range (°)	-40 ~ +85°C	Angular resolution (°)	18
Storage temperature range	-40 ~ +95°C	Speed Range (km/h)	-150 ~ +150
Working frequency (GHz)	76-77	Speed Accuracy (m/s)	0.15
Transmit power (dBm)	12	Detectability (m)	65m
Modulation mode	FMCW	Distance Accuracy (m)	0.13
Antenna form	4TX, 4RX	Distance Resolution (m)	0.19
Traceable target number _{MAX}	31	Waterproof grade	IP6K7



Display Specifications

ITEM	Parameter
Rated working voltage (V)	12V/24V
Operating voltage range (V)	9-32V
Working current	<500mA@12V
Operating temperature range (°)	-40 ~ 80
Storage temperature range (°)	-40 ~ 85
Volume	≥90dB@12V/10cm

Function

Self-diagnosis

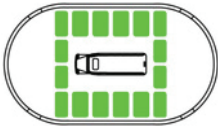

When the system IGN is on and the reverse gear is engaged in, the system starts self-diagnosis, the result showed as below:

No.	Self-diagnosis results	LED bar	Buzzer built-in	Note
1	Pass		Beep once	Normal Working
2	MOIS Radar Missed		Beep twice	Only BSIS function available

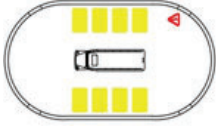
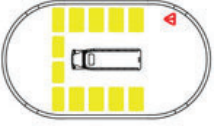
Function

No.	Self-diagnosis result	LED bar	Buzzer built-in	Note
1	BSIS Radar Disconnect		Beep once	Only MOIS function available
2	MOIS And BSIS Radar Missed		Beep twice	Not working completely

Function

No.	Self-diagnosis result	LED bar	Buzzer built-in	Note
3	GPS Signal valid		GPS ON	Normal
4	GPS Signal invalid		GPS Blink	The working performance of this system might not be good as designed.

Function

No.	Self-diagnosis result	LED bar	Buzzer built-in	Note
5	GPS disconnect		GPS OFF	The working performance of this system might not be good as designed.

Function

BSIS static detection function (Vehicle speed $V_{\text{vehicle}}=0\text{km/h}$)

a. When there's pedestrian or cyclist come into the red area from rear, the display will provide warning signal (LED bar keeps on in red color), as below picture. If the driver turn on the corresponding turning signal, the display will provide collision warning (color bar show in red and blink, buzzer beeps twice), the external output cable will provide a high level output.

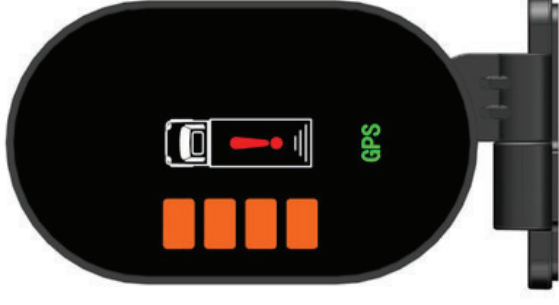
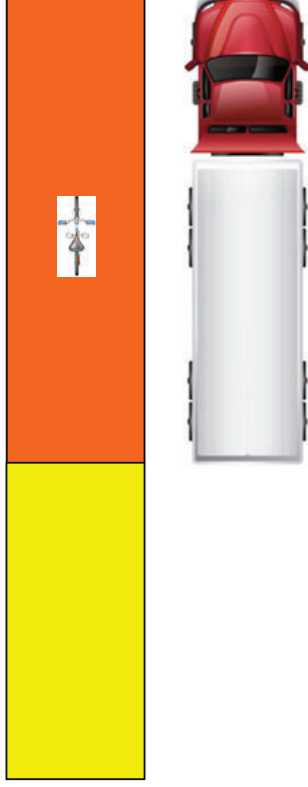

Function

- b. When there's pedestrian or cyclist come into the yellow area from rear and will overtake the subject vehicle in 12s(TTC), the display will provide warning signal (LED bar keeps on in red color) .
----When $TTC < 2s$, If the driver turn on the corresponding turning signal, the display will provide collision warning (color bar show in red and blink, buzzer beeps twice). the external output cable will provide a high level output.

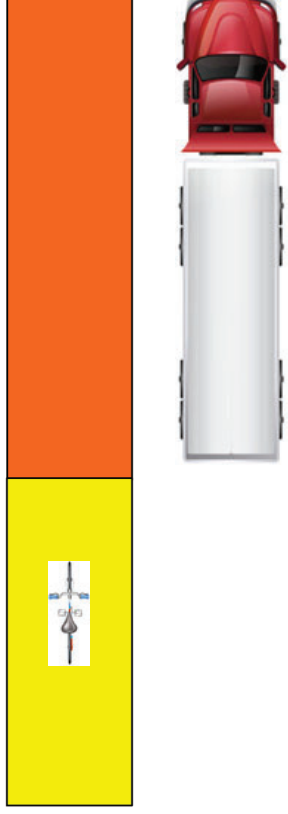

Function

BSIS dynamic test detection function (30km/h \geq Vehicle speed \geq 0km/h)

a. When there's a pedestrian or cyclist come into the red area from rear or stay in the red area, the display will provide a warning signal (LED bar keeps on in red color), as below

-----If the driver turns on the corresponding turning signal, the display will provide a collision warning (color bar shows in red and blink, buzzer beeps twice). The external output cable will provide a high level output.

-----If the VRU enters the area near the front of the vehicle (the distance to the side of the vehicle is less than 1m, and the distance to the front of the vehicle is less than 5m), the display will provide a collision warning (color bar shows in red and blink, buzzer beeps twice). The external output cable will provide a high level output.

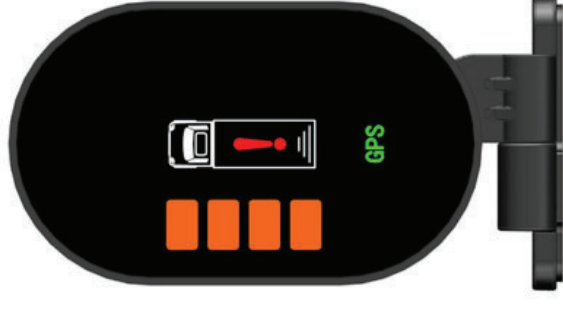

Function

b. When there's pedestrian or cyclist come into the yellow area from rear and will overtake the subject vehicle in 12s(TTC), the display will provide warning signal (LED bar keep on in red colour).

----when $TTC < 3s$, If the driver turn on the corresponding turning signal, the display will provide collision warning (color bar show in red and blink, buzzer beeps twice). the external output cable will provide a high level output.

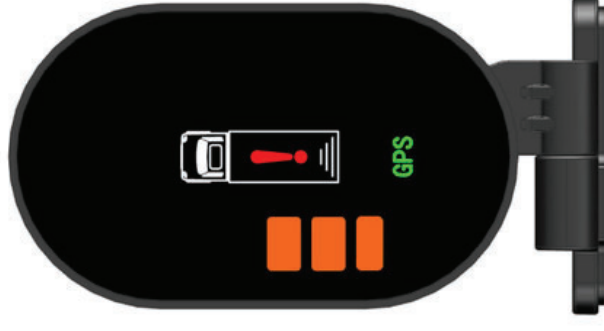

Function

Blind spot detection function (Vehicle speed $V_{\text{vehicle}} > 30 \text{ km/h}$)

a. When there's a moving object in the red area from the rear or stay in the red area, the display will provide a warning signal (LED bar keeps on in red color), as shown in the picture below.

---- If the driver turns on the corresponding turning signal, the display will provide a collision warning (color bar shows in red and blinks, buzzer beeps twice). The external output cable will provide a high level output.

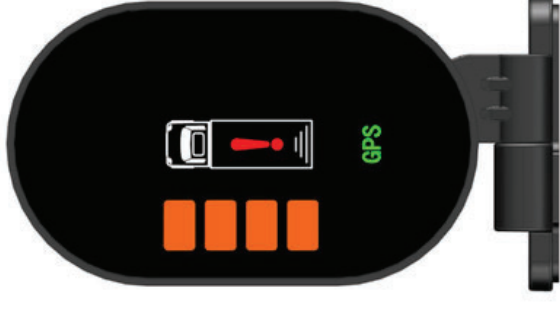
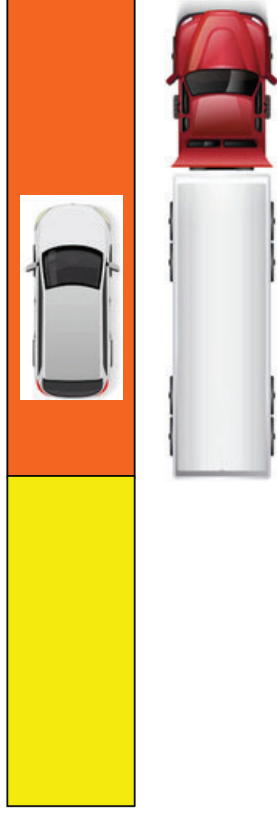

Function

- b. When there's a moving object coming from the rear and will overtake the subject vehicle in 3s(TTC), the display will provide a warning signal (LED bar keeps on in red color) .
- If the driver turns on the corresponding turning signal, the display will provide a collision warning (color bar shows in red and blink, buzzer beeps twice). The external output cable will provide a high level output.

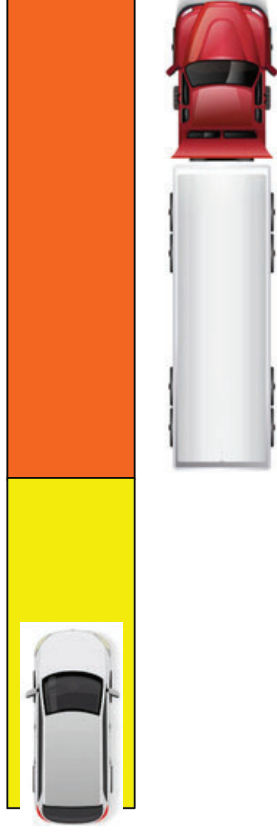

Function

MOIS static detection function Vehicle speed $V_{\text{vehicle}} = 0 \text{ km/h}$

a. When pedestrians or bicycles (VRUs) appear in the yellow area (see below picture), the display will show obstacles.

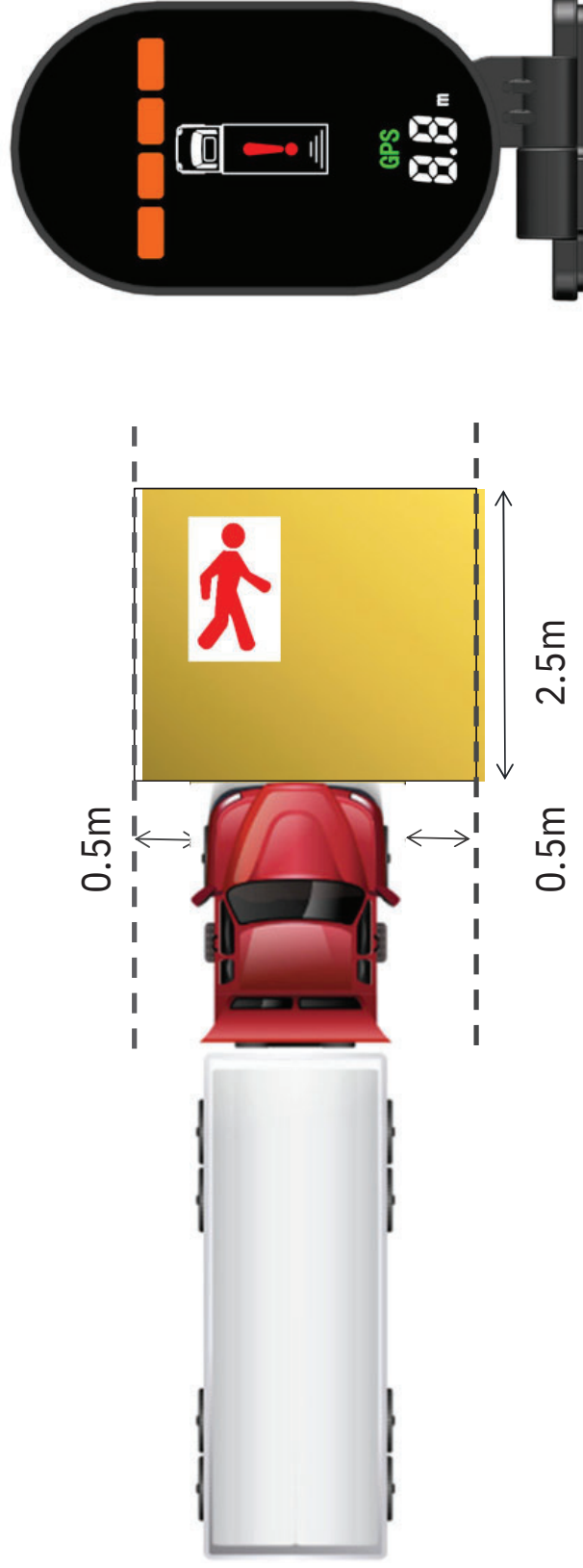

Function

MOIS static detection function (Vehicle speed $V_{\text{vehicle}}=0\text{km/h}$)

c. When pedestrians or bicycles (VRUs) appear from the right side of the yellow area (see below picture), and the $\text{TTC} < 1.4\text{s}$, the display shows as below:

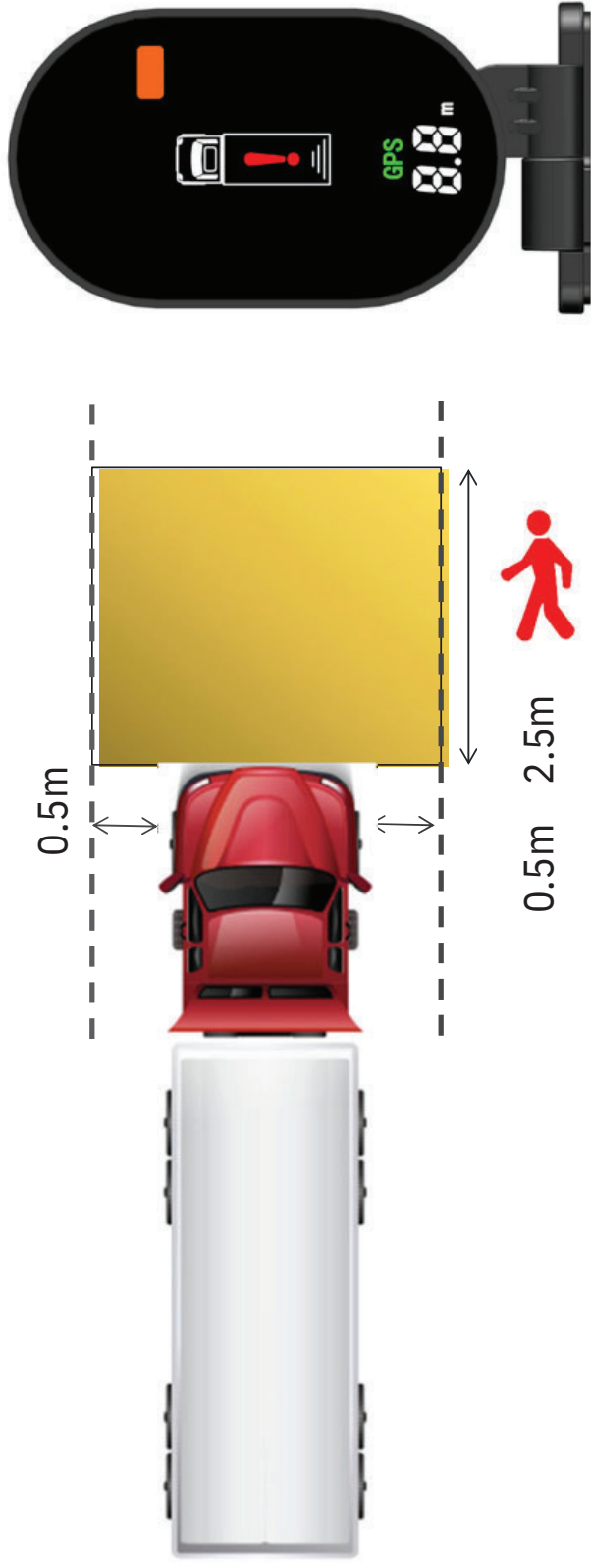

Function

MOIS static detection function (Vehicle speed $V_{\text{vehicle}}=0\text{km/h}$)

b. When pedestrians or bicycles (VRUs) appear from the left side of the yellow area (see below picture), and the $\text{TTC} < 1.4\text{s}$, the display show as below:

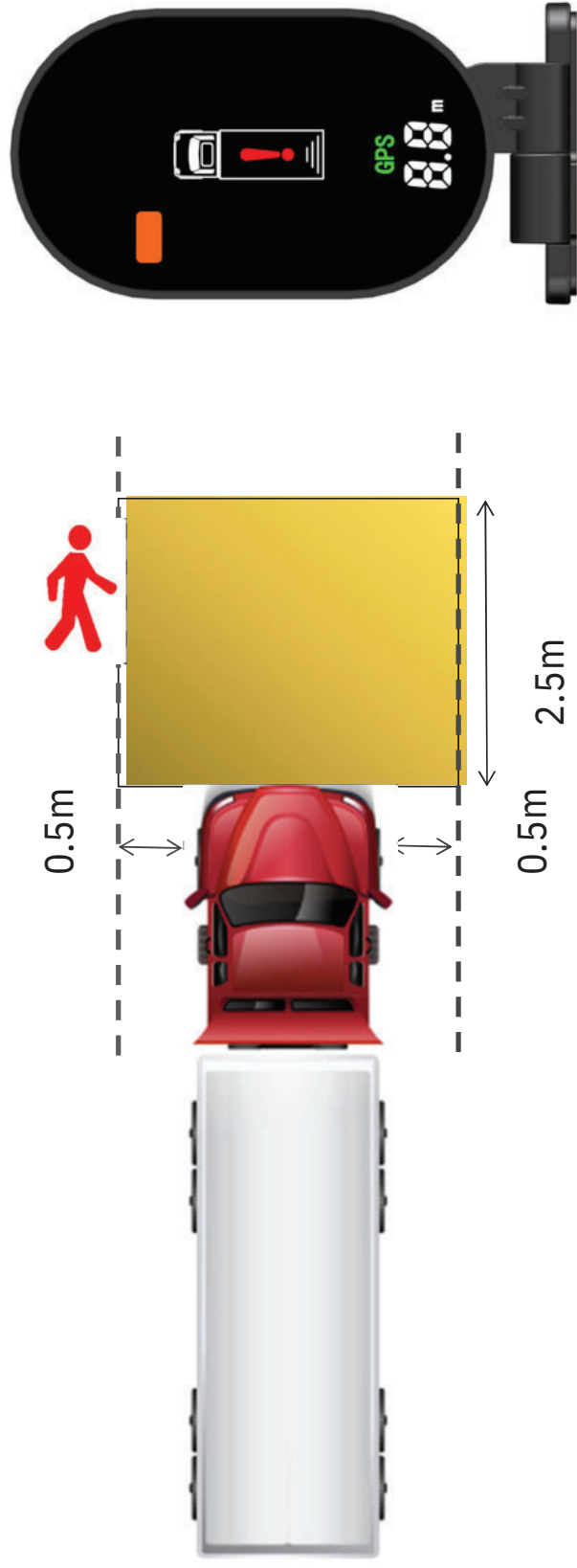

Function

MOIS dynamic detection function (Vehicle speed $0\text{km/h} < \text{Vvehicles} \leq 15\text{km/h}$)

- When pedestrians or bicycles (VRUs) appear in the front of the yellow area as below picture, and $\text{TTC} < 2\text{s}$, the display will show obstacle distance.

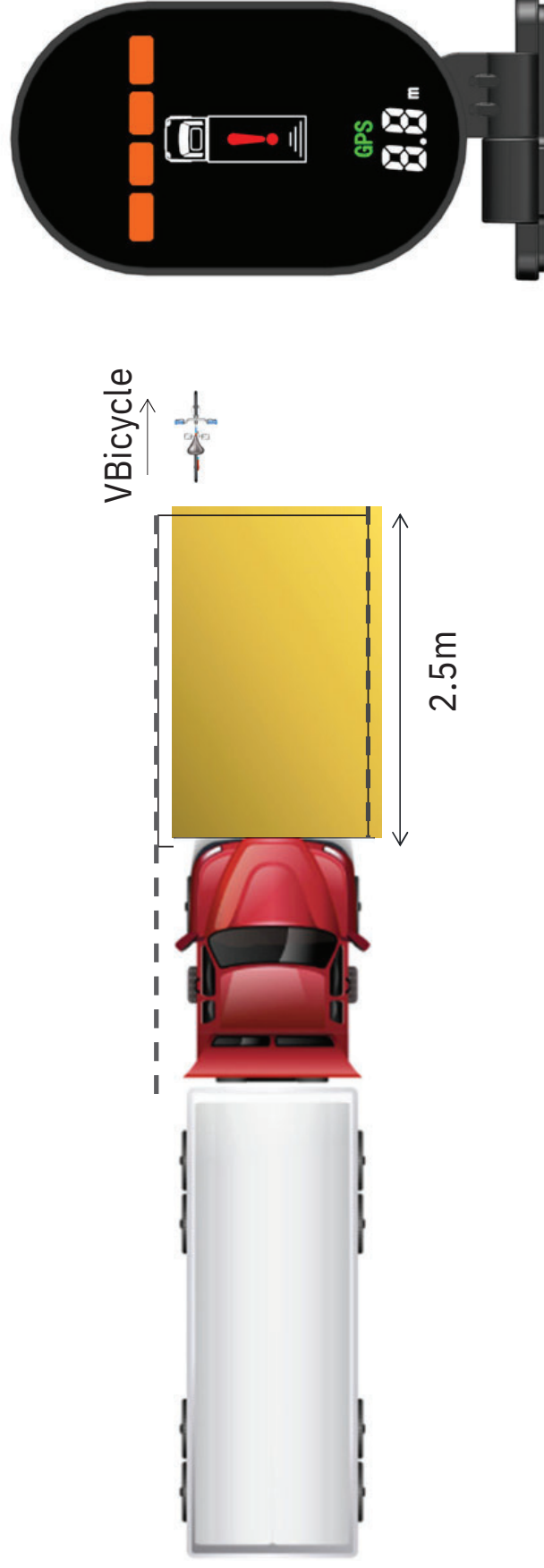

Function

MOIS dynamic detection function (Vehicle speed $0\text{km/h} < \text{Vehicles} < 15\text{km/h}$)

b. When pedestrians or bicycles (VRUs) appear in the yellow area as below picture, and $\text{TTC} > 2\text{S}$, the display will show obstacle distance;

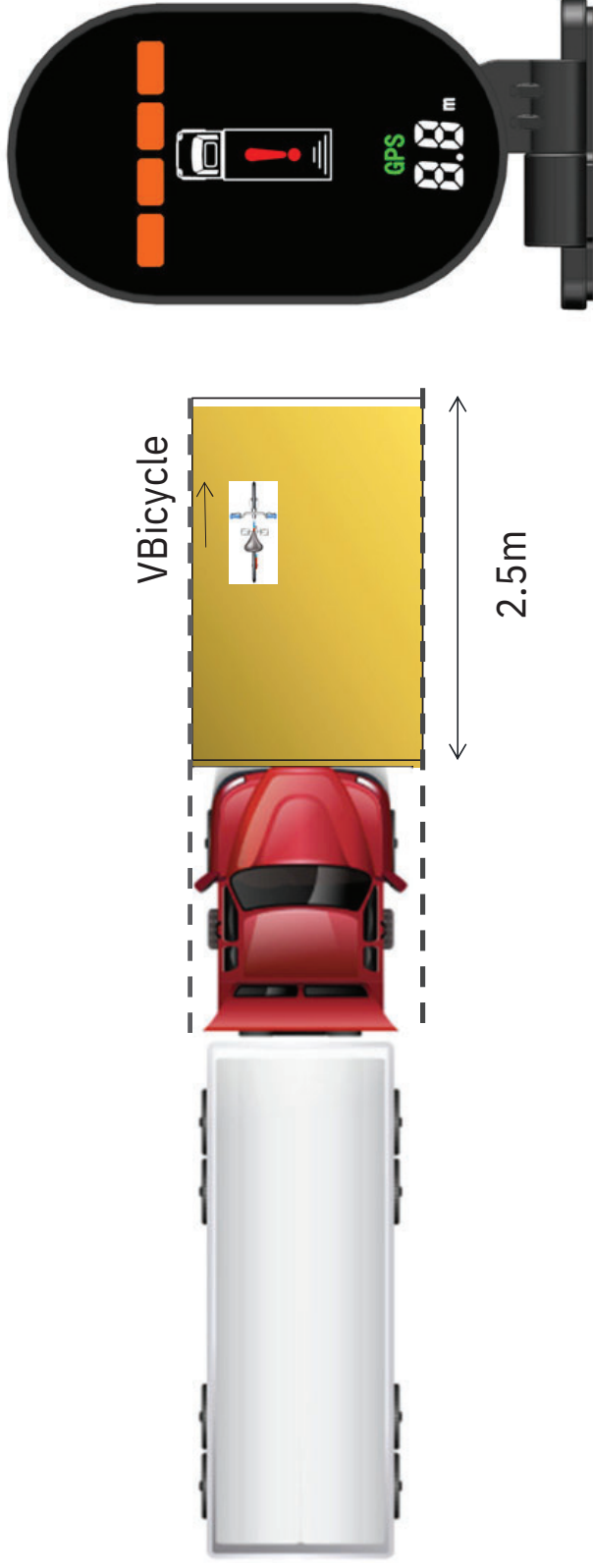

Function

MOIS dynamic detection function (Vehicle speed $0\text{km/h} < V_{\text{vehicles}} < 15\text{km/h}$)

c. When pedestrians or bicycles (VRUs) appear in the yellow area (see below picture), and the collision time $\text{TTC} < 2\text{s}$, the external output cable will provide a high level output, the display will show obstacle distance, and the buzzer built in display will beep twice (Bi-Bi-).

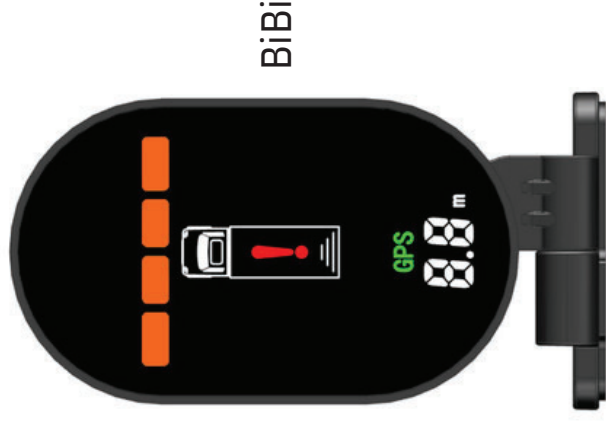

Note: $\text{TTC} = D / (V_{\text{vehicle}} - V_{\text{VRU}})$

D: The distance between vehicle and target

V: VRU Target object speed

V_{vehicle} : Vehicle speed

Function

Display setup function



Setup button:

Metric and Imperial system setup.

Volume button

Adjust the buzzer volume

Function

Detection area and Sensor Location setup by handheld setup tool

t1: The time of the target vehicle overtake the subject vehicle (Default:3s)

d1:BSIS hazardous area length (Default: 10m)

d2:BSIS hazardous area width (Default:3m)

d3:BSIS radar position to frontmost of vehicle (Default: 2.5m, Set according to actual installation position)

d7:BSIS front extension area (Default: 2.5m)

d4:MOIS warning area length (Default:2.5m)

d5:MOIS warning area width of left side (Default:1.5m)

d6:MOIS warning area width of right side (Default:1.5m)

