

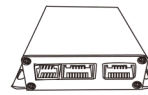

DVS 2024 AI Sensor V1 System
Installation Manual

Package Content



ECU×1



AI sensor×1
black



AI sensor×1
white



MOIS Camera×1



LED DISPLAY×1

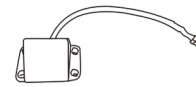

77GHz radar X 1



Sensor Cable ×1



A pillar Led×1

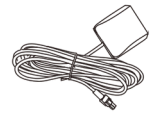

GPS module
With gravity
sensor×1

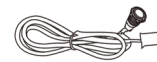

Mute switch×1

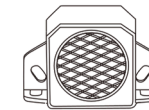

External speaker×1

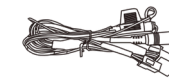

Power harness×1



Display Cable×1

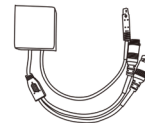

Wifi calibrationModule ×1
Wifi calibration module is not
included in every kit, it can be
used for many times



3m Camera
Extension cable×3

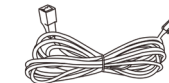

2.7m display
extension cable×1



Bracket for
led display×1



Angle Sleeve
for AI sensor ×1



Alarm extension cable×1

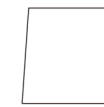

3m tape×1

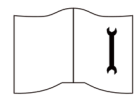

Installation Guide×1

AI camera Specification

Operation Voltage:	12~36V
Operation Current:	<500mA
Operation Temperature:	-40 ~ +85 degrees
Camera fov:	Forward-facing camera : 150
Resolution:	degree 1080P 30pfs
Detection Range:	Front 2 meters (L) * 3 meters (W)
Self-checking Function:	Blocked, dirty, poor connection

Sensor Specification

Sensor Frequency:	58 KHz
Working Voltage:	12 ~ 32V
Working Current:	< 500mA
Operating Temperature:	- 40 ~ 80°C
Sensor Waterproof IP Rating:	IP69
Alarm Distance:	2.5m
Horizontal Detection Angle:	120 degree
Vertical Detection Angle:	60 degree
Number of sensor:	up to 10 sensors
GPS search time:	< 60 seconds

External Alarm specification

Rated Voltage:	DC 12 / 24V
Working Voltage:	12 ~ 36V
Working current:	< 500mA@24V
Operating temperature:	- 40 ~ 85°C
Storage temperature:	- 40 ~ 85°C
Sound Frequency:	500Hz ~ 7KHz
Duty cycle:	3.0S/T(Vocal Reverse Warning) 3.3S/T(Vocal Left Turn Warning) 3.3S/T(Vocal Right Turn Warning)
Waterproof IP rating:	IP69

77GHz radar technical Specification

Detection Target Type:	moving targets(vehicles / pedestrians obstacles, etc.)
Number Of Transceiver Links:	2T4R
Working Mode:	FMCW (CS + MIMO)
Operating Frequency Range:	76GHz ~ 77GHz
Eirp:	≤ 30dBm
Distance Detection Range:	0.15m ~ 120m
Horizontal Detection Range:	± 75°
Vertical Detection Range:	± 10°
Distance Measurement Accuracy:	± 0.1m
Distance Resolution:	0.25m
Relative Speed Detection Range:	-400km/h ~ +200km/h
Relative Speed Measurement Accuracy:	± 0.15km/h
Relative Velocity Resolution:	0.5k m /h
Angle Measurement Accuracy:	± 0.4°
Angular Resolution:	4°
Maximum Number Of Target Tracks:	128
Data Output Refresh Rate:	≤ 50ms

System Layout

MOIS camera is installed on the front windshield of the cab

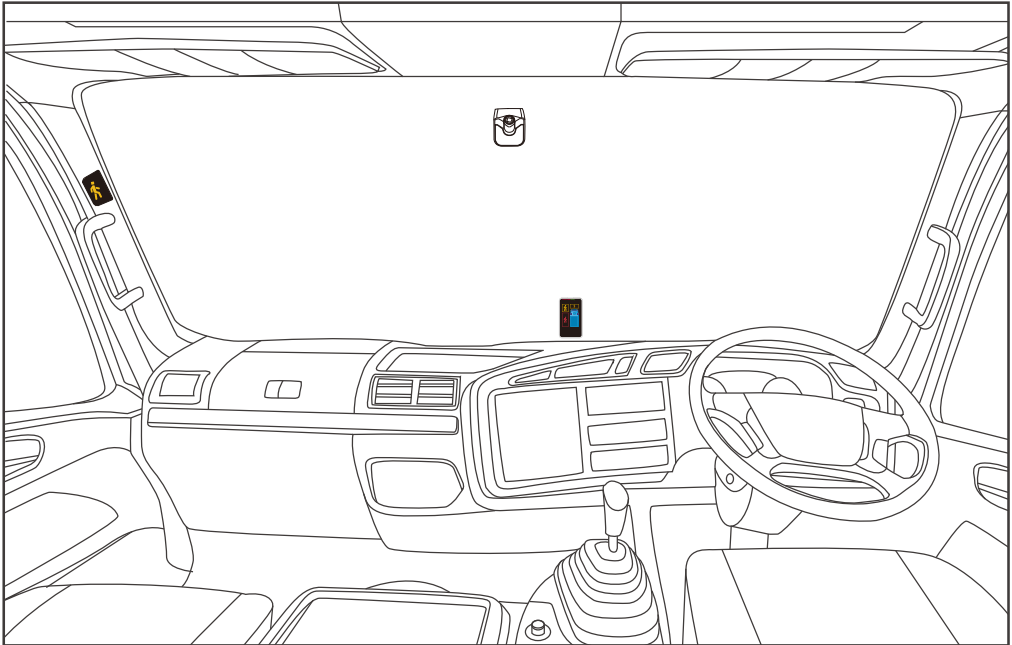
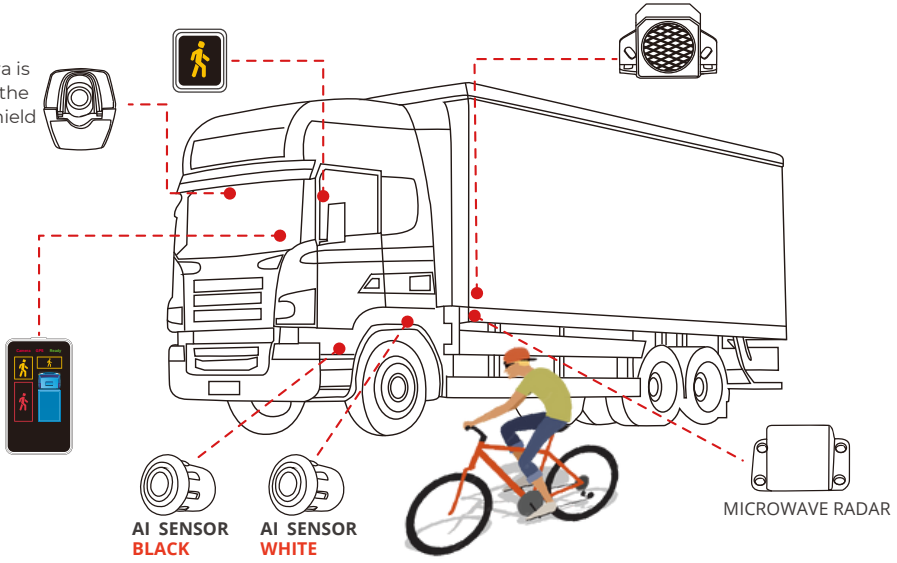

Wiring Diagram

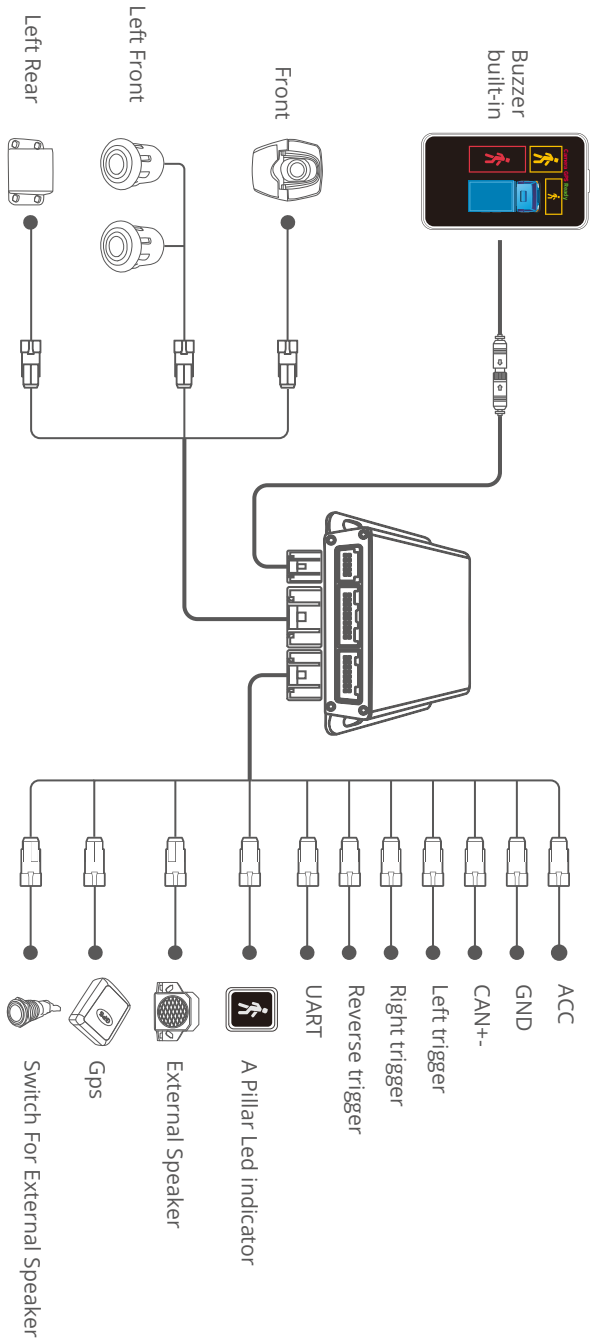

Camera installation

1. MOIS Camera :

- Ensure the camera's view angle covers the bottom of the front windshield and covers as far forward as possible.
- Avoid any shadows or reflections.
- The camera should be in the middle and within the wiper range.

Ai Camera Calibration

- Connect the camera with the calibration tool and turn on the power.

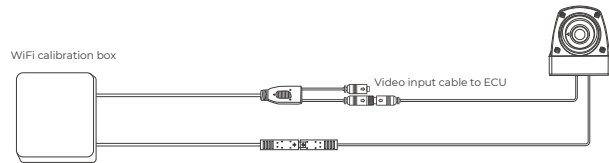

- Connect WiFi signal, WiFi signal name: ai camera calibration.
- Select the right camera to be calibrated: front, back, left, right.
- Mark the alarm area on the ground (we can use the traffic cone to set the detection zone).
- Move the ruler line on the mobile app to coincide with the ground marking.
- After clicking **WRITE**, check whether the ruler line on the test monitor is consistent with the position on the application app.
- If consistent, the calibration is completed.

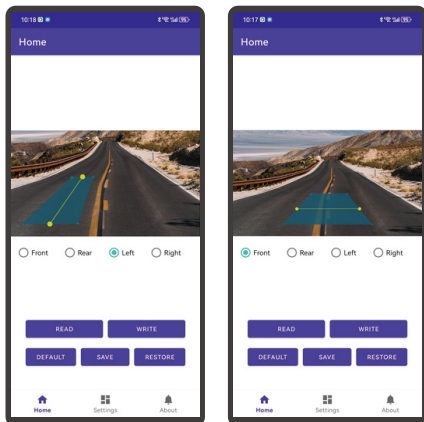

AI sensor installation

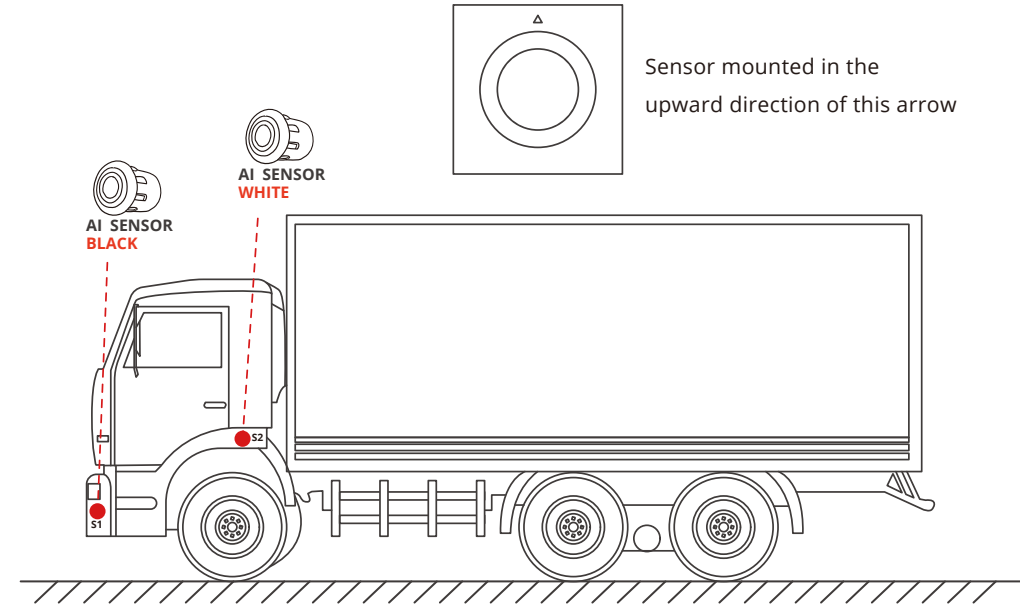

- Recommended installation height: 60-80cm, use 4 or 8 degree angle sleeve.
- When installation height is higher than 80cm, use 0 degree angle sleeve.
- S1 must be black, S2 must be white. Installation height for S1 must be same or lower than S2. Gap between S1 and S2 is not greater than 60cm.
- Distance between S1 and S2 should be from 1.2-1.7m.
- Please be attention when you install S2, find a good place that will avoid detecting truck body.
- AI sensor working logic: It only triggers alarms for moving objects; stationary objects do not elicit alarms. However, it can be configured to provide an alarm for stationary objects within the optional range of 30-60cm.

77GHz radar installation

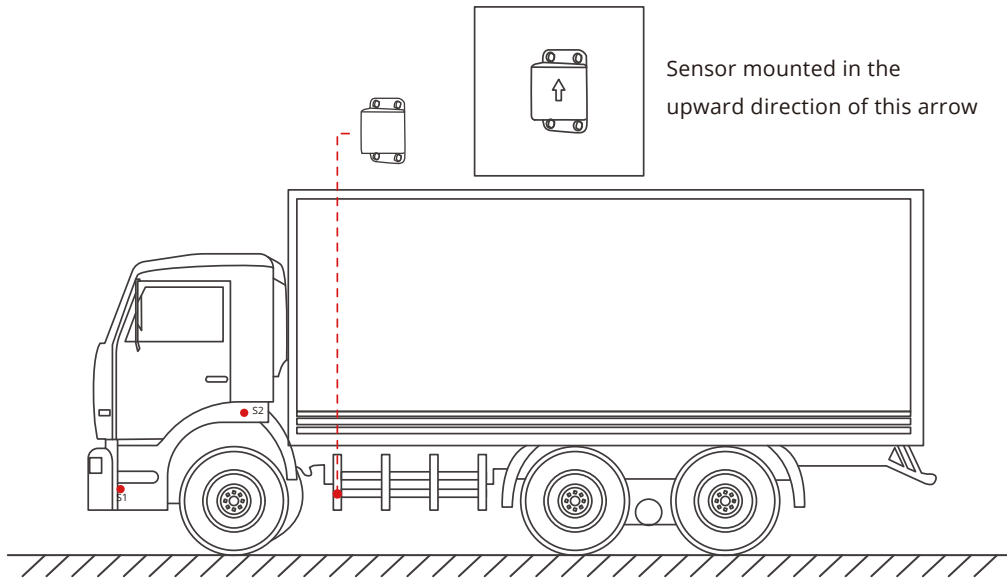

- 1、 Installation height: 0.6-1m.
- 2、 Installation angle is 0 degrees, should not be tilted towards the ground. There should be no obstructions in front of the radar.
- 3、 Radar should be installed close to S2 to cover blind spot area.
- 4、 Radar only detects moving objects, not detect stationary objects.
- 5、 The side radar detects moving objects in the detection area, the main display and A-pillar light will be lit. If the turn signal is activated, there will be an audible alarm and the LED light will flash

System working condition

Self Test



When GPS is faulty, GPS icon will be showing on the led display.



When Sensor are faulty, Sensor icon will be showing on the led display.

Handbrake function

When handbrake is on, it gives 12-24V output, Speaker on the led display is muted when a VRU is detected.

When handbrake is off, it gives 0v or GND output, speaker on the led display generates audio alarm when a VRU is detected.

System Working Condition

MOIS works from 0.1-5km/h.
MOIS stops alarm above 5km/h.

Sensor works from 0.1-30km/h.
Sensor stops alarm above 30km/h. Both led display and A pillar indicator show like the picture.



Led Display



A Pillar LED Indicator

System Trouble-Shooting

Problem	Solution
Sensor doesn't work	a) Check whether the power supply is connected correctly and ensure that the vehicle turns on ACC. b) Whether all connectors are connected correctly and ensure no looseness or poor connection.
Sensor does not turn off properly	a) Check if the GPS is connected correctly. b) Ensure that the GPS satellite search is normal, and the GPS antenna is not blocked by metal.
False Alarm	a) Check if the power supply voltage is greater than 11V. b) The sensor surface is without obstructions, including: water, snow, mud and other objects. c) Ensure sensors are installed at correct direction, the arrow mark on the sensor should be upward.